

ORIMA®

2021

MAZUMTIRDZNIECĪBAS CENAS Baltija



ORIMA®
The Finnish Quality
Since 1960

SATURA RĀDĪTĀJS

LIETUS ŪDENS NOTEKSISTĒMAS	4
P13, P87, P10	4
K12, K9x9	6
P10	8
Tehniskā informācija	9
SIENAS KĀPNES	10
AVĀRIJAS KĀPNES	12
JUMTA KĀPNES, PAKĀPIENI	13
JUMTA KĀPNES	14
JUMTA LAIPAS	16
SNIEGA BARJERAS	18
PERFORĒTĀS SNIEGA BARJERAS.....	20
JUMTA NOŽOGOJUMI	21
DROŠĪBAS SLIEDE	22



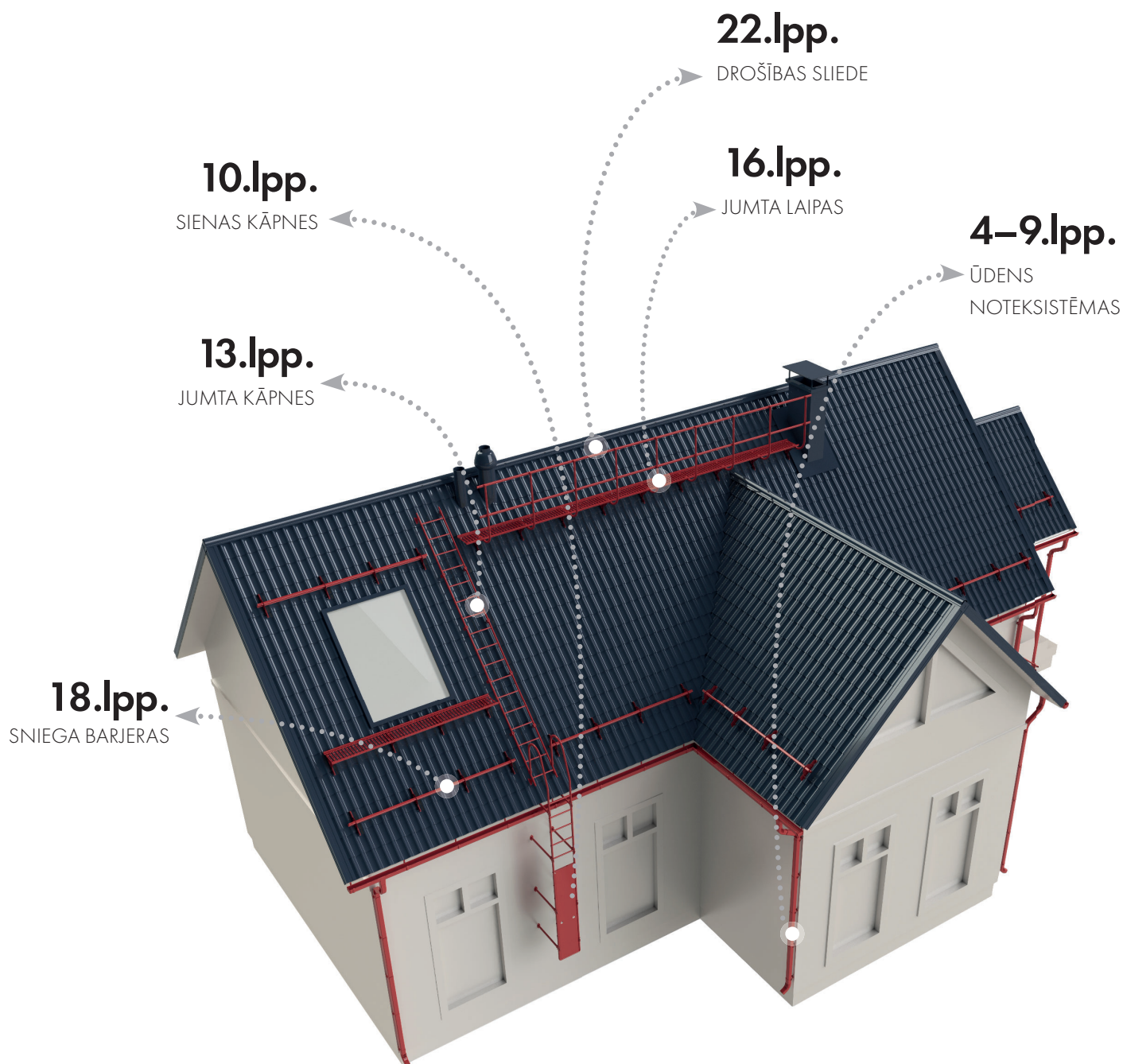

METĀLA
DAKSTIŅPROFILS

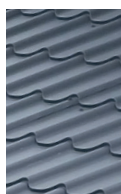

PROFILĒTS
JUMTA SEGUMS

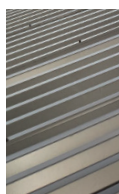

MĪKSTIE
SEGUMI



VALCPROFILS

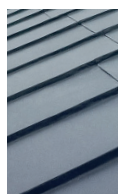

DABĪGAIS
DAKSTIŅŠ

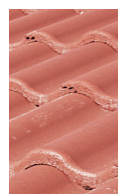

ETERNIT



CEMBRIT



LIETUS ŪDENS NOTEKSISTĒMAS

P13, P87, P10











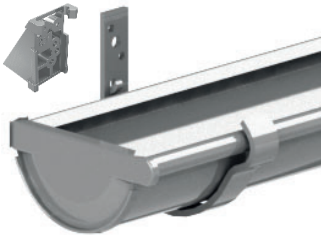

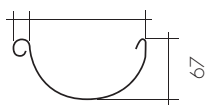



*Standarta krāsas: RR20 Balta RR23 Tumši pelēka RR32 Tumši brūna RR33 Melna



Īpašās krāsas +20 %: Pēc pieprasījuma RR11 Tumši zaļa RR21 Gaiši pelēka RR22 Pelēka RR29 Sarkana RR750 Ķieģeļu sarkana



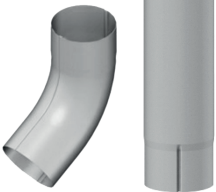
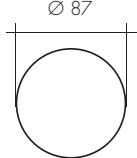

Krāsa ar metālisku spīdumu +30 %: RR41

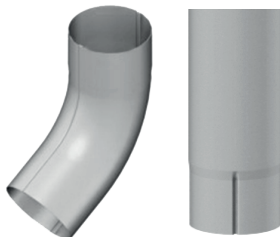
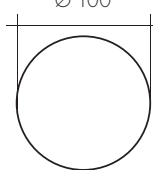
Nestandarta garumi +10 %

PRODUKTI	KODS	PIEGĀDES LAIKS	EUR*	EUR* BEZ PVN	APRAKSTS	
P13 TEKNE 	3 m 	10150	5	15,95		
	4 m 	10170	5	19,31		
	5 m 	10010	5	24,18		
	6 m 	10020	5	28,99		
	P13 TEKNE					
	P13 REGULĒJAMS TEKNES ĀĶIS	10730	5	3,98	1 m	
	P13 ĪSAIS TEKNES ĀĶIS	10110	5	2,45	1 m	
	TEKNES ĀĶA REGULATORS	1:4 	10580	5	0,65	
		1:3 	10590	5	0,65	
		1:2 	10600	5	0,65	
		1:1,5 	10610	5	0,65	
	P13 TEKNES ĀĶIS	1:2,5 	10160	5	2,63	1 m
	P13 TEKNES ĀĶIS	1:3 	10130	5	2,63	1 m
	P13/K12 ĀĶA AIZMUGURĒJĀ DETAĻA: K	11150	5	1,79		
	P13 GARAIS TEKNES ĀĶIS	10120	5	2,82	1 m	
	P13/K12 KRONŠTEINA PAPILDINĀJUMS	11140	5	1,79		
	P13 TEKNES GALS	10040	5	2,22		
	P13 SAVIENOTĀJS	10050	5	4,05		
	P13 SAVIENOTĀJS (AR PAPILDINĀJUMU)	10060	5	3,83		
	P13 IEKŠĒJAIS LĪKUMS	10070	5	28,09		
P13 ĀRĒJAIS LĪKUMS	10080	5	28,09			

PRODUKTI	KODS	PIEGĀDES LAIKS	EUR*	EUR* BEZ PVN	APRAKSTS
P87 NOTEKCAURULE 	P13/P87 KONEKTORS	13500	5	5,72	
	P87 NOTEKCAURULE	1,0 m 	13530	5	
		2,5 m 	13540	5	15,12
	P87 LĪKUMS	13520	5	4,63	
	P87 NOTEKCAURULES STIPRINĀJUMS	13560	5	2,96	1,5 m
	P87 PILTUVE	13610	5	41,36	
	P87 T-VEIDA LĪKUMS	13620	10	42,28	
	P87 NOTEKAS VĀRSTS	13670	10	32,79	

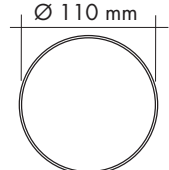
P10 NOTEKCAURULE 	P13/P10 KONEKTORS	10090	5	6,56	
	P10 NOTEKCAURULE	1,0 m 	13010	5	
		2,5 m 	13020	5	18,71
	P10 LĪKUMS	13180	5	5,65	
	P10 IZVADS	13190	5	9,05	
	K9*9/P10 NOTEKCAURULES STIPRINĀJUMS	13050	5	1,96	= KODS 13040 + 12040. 1,5 m
		13040	5	0,57	
		12040	5	1,40	
	P10 NOTEKCAURULES STIPRINĀJUMS M2000	13030	5	3,45	1,5 m
	P10 PILTUVE	13140	10	35,02	
P10 NOTEKAS VĀRSTS	13660	10	35,36		
P10 T-VEIDA LĪKUMS	13680	10	40,99		

VANDĀĻDROŠA NOTEKCAURULE 	VANDĀĻDROŠA NOTEKCAURULE 108 mm, TAISNA	2,0 m 	15010	10	74,70	
	VANDĀĻDROŠA NOTEKCAURULE 108 mm	2,0 m 	15020	10	79,56	
	KRONŠTEINS APAĻAI CAURULEI 108 mm	15030	10	5,79		

LIETUS ŪDENS NOTEKSISTĒMAS

K12, K9x9

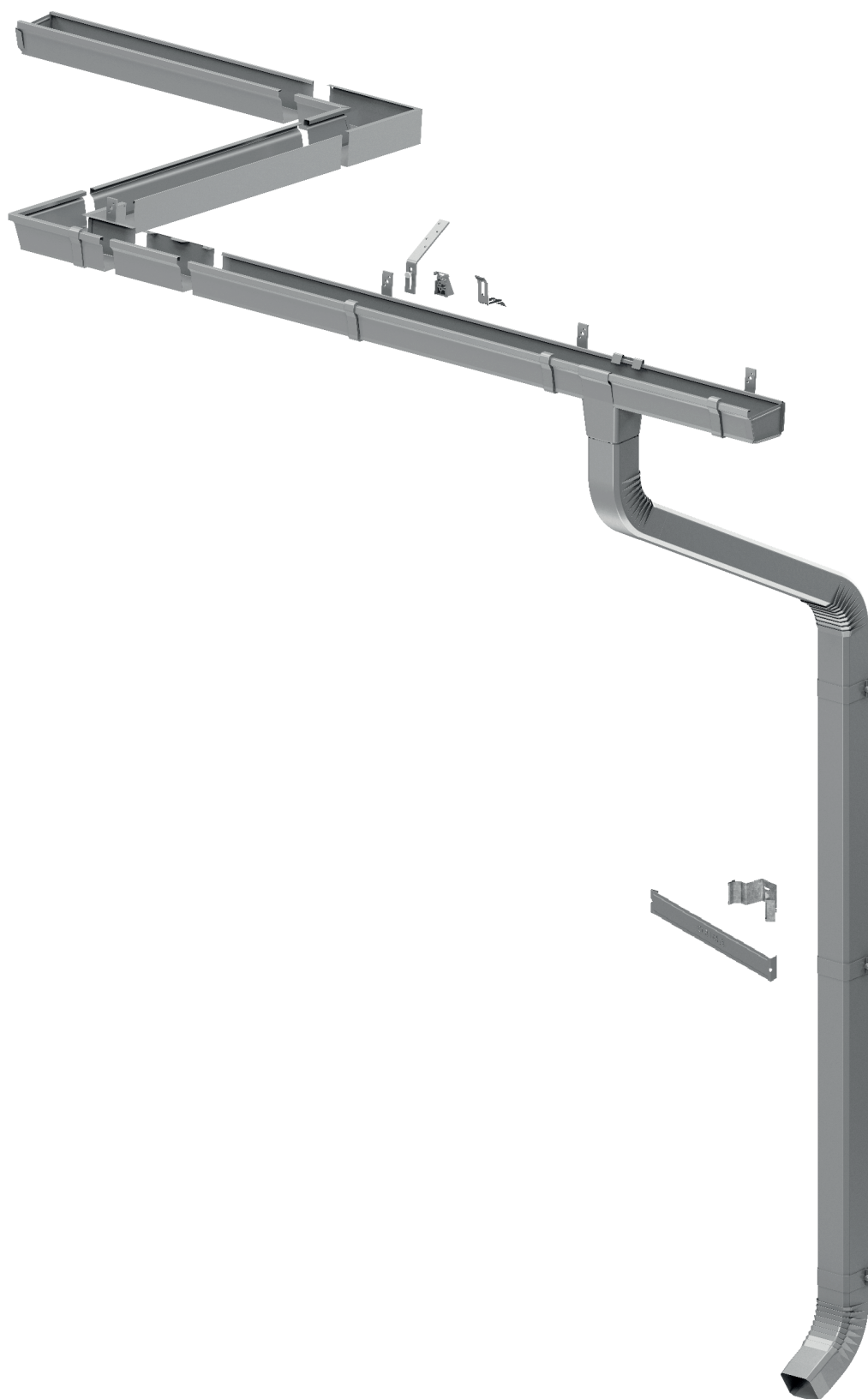









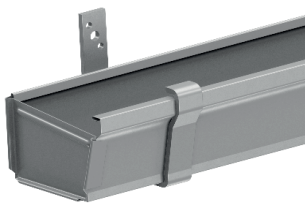

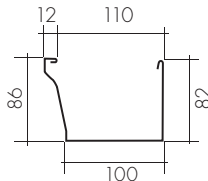







*Standarta krāsas: RR20 Balta RR23 Tumši pelēka RR32 Tumši brūna RR33 Melna

Īpašās krāsas +20 %: Pēc pieprasījuma RR11 Tumši zaļa RR21 Gaiši pelēka RR22 Pelēka RR29 Sarkana RR750 Ķieģeļu sarkana

Krāsa ar metālisku spīdumu +30 %: RR41

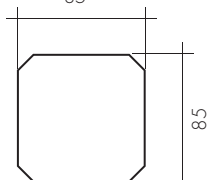
Nestandarta garumi +10 %

PRODUKTI	KODS	PIEGĀDES LAIKS	EUR*	EUR* BEZ PVN	APRAKSTS
K12 TEKNE 	3 m 	11170	5	19,41	
	4 m 	11260	5	22,23	
	5 m 	11010	5	29,43	
	6 m 	11020	5	35,32	
K12 TEKNE					
K12 TEKNES ĀĶIS	11110	5	2,25	1 m	
TEKNES ĀĶA REGULATORS	1:4 	10580	5	0,65	
	1:3 	10590	5	0,65	
	1:2 	10600	5	0,65	
	1:1,5 	10610	5	0,65	
K12 TEKNES ĀĶIS	1:2,5 	11180	5	2,60	1 m
K12 TEKNES ĀĶIS	1:3 	11120	5	2,60	1 m
K12 ĀĶA AIZMUGURĒJĀ DETAĻA: K	11150	5	1,79	1 m	
K12 IEKŠĒJAIS KRONŠTEINS	11130	5	0,62	1 m, galv.	
K12 KRONŠTEINA PAPILDINĀJUMS	11140	5	1,79		
K12 TEKNES LABAIS GALS	11040	5	1,27		
K12 TEKNES KREISAIS GALS	11050	5	1,27		
K12 ĀRĒJAIS LĪKUMS	11070	5	28,09		
K12 IEKŠĒJAIS LĪKUMS	11080	5	28,09		

PRODUKTI	KODS	PIEGĀDES LAIKS	EUR*	EUR* BEZ PVN	APRAKSTS	
K9*9 NOTEKCAURULE 	K12 KONEKTORS	11090	5	9,48	85	
	K9*9 NOTEKCAURULE	1,0 m 	12010	5	8,88	
		2,0 m 	12020	5	12,91	
	K9*9 IZVADS	2,6 m 	12030	5	16,85	
	K9*9 AUGŠĒJAIS LĪKUMS	12080	5	4,75		
	K9*9 APAKŠĒJAIS LĪKUMS	12090	5	7,15		
	K9*9 STIPRINĀJUMS M2000	12070	5	2,96	1,5 m	
	K9*9/P10 NOTEKCAURULES STIPRINĀJUMS	13050	5	1,96	= KODS 13040 + 12040. 1,5 m	
		13040	5	0,57		
		12040	5	1,40		
	K12 KONEKTORS	11100	5	2,00		
	K9*9 S-VEIDA LĪKUMS 5 cm	12100	10	14,34		
K9*9 S-VEIDA LĪKUMS 10 cm	12110	10	14,34			
K9*9 S-VEIDA LĪKUMS 20 cm	12120	10	14,34			
K9*9 S-VEIDA LĪKUMS 15 cm	12130	10	14,34			
K9*9 NOTEKAS VĀRSTS	12170	10	38,58			
K9*9 NESTANDARTA LĪKUMS	12970	10	26,90			

VANDĀLDROŠA NOTEKCAURULE

K9*9 VANDĀLDROŠA NOTEKCAURULE 2 m	2,0 m 	12150	10	94,91	
K9*9 KRONŠTEINS KANTAINAI CAURULEI		12160	10	5,35	

LIETUS ŪDENS NOTEKSISTĒMAS

P10

PRODUKTI	KODS	PIEGĀDES LAIKS	EUR*	EUR* BEZ PVN	APRAKSTS
P10 NOTEKCAURULE					
	1,0 m	13010	5	8,48	
P10 NOTEKCAURULE					
	2,5 m	13020	5	18,71	
P10 AUGŠĒJAIS LĪKUMS	13070	5	6,29		
P10 APAKŠĒJAIS LĪKUMS	13080	5	8,21		
P10 IZVADS	13090	5	7,05		
P10 NOTEKCAURULES STIPRINĀJUMS M2000	13030	5	3,45	1,5 m	
K9*9/P10 NOTEKCAURULES STIPRINĀJUMS	13050	5	1,96	= KODS 13040 + 12040. 1,5 m	
	13040	5	0,57		
	12040	5	1,40		
P13 ĪSĀ PILTUVE	10100	10	2,65		
P10 S-VEIDA LĪKUMS 5 cm	13100	10	22,84		
P10 S-VEIDA LĪKUMS 10 cm	13110	10	22,84		
P10 S-VEIDA LĪKUMS 15 cm	13120	10	22,84		
P10 S-VEIDA LĪKUMS 20 cm	13130	10	22,84		
P10 SPECIĀLAIS LĪKUMS	13650	10	26,90		

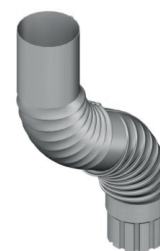
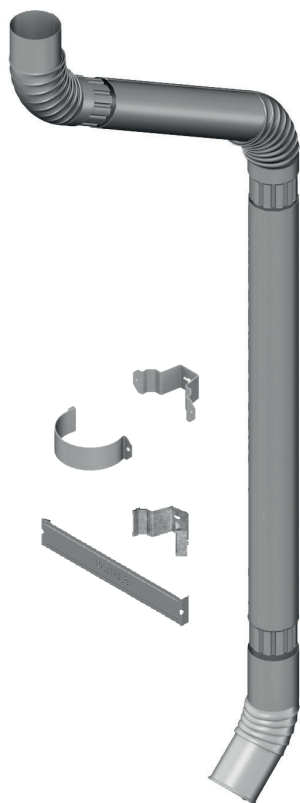

PRODUKTI	KODS	PIEGĀDES LAIKS	EUR*	EUR* BEZ PVN	APRAKSTS
Tērauda ruļļi					
RR20, -23, -32, -33	Plotis 300 mm	55530	5	4,75	
ĪPAŠĀS KRĀSAS	Plotis 300 mm	56030	10	5,66	

*Standarta krāsas: RR20 Balta RR23 Tumši pelēka RR32 Tumši brūna RR33 Melna

Īpašās krāsas +20 %: Pēc pieprasījuma RR11 Tumši zaļa RR21 Gaiši pelēka RR22 Pelēka RR29 Sarkana RR750 Ķieģeļu sarkana

Krāsa ar metālisku spīdumu +30 %: RR41

Nestandarta garumi +10 %

LIETUS ŪDENS NOTEKSISTĒMAS

Tehniskā informācija

JUMTA PLAKNES UN NOTEKCAURULES IZVIETOJUMS

NOTEKCAURULE	NOTEKCAURULES IZVIETOJUMS UN DAUDZUMS		
P87	150 m ²	100 m ²	200 m ²
P10	225 m ²	150 m ²	300 m ²
K9x9	190 m ²	130 m ²	250 m ²





SADERĪBA

NOTEKCAURULE	TEKNES IZMĒRS	
	P13	K12
P10	X	
P87	X	X
K9x9		X
Vandāldroša notekcaurule	X	
Vandāldroša notekcaurule		X

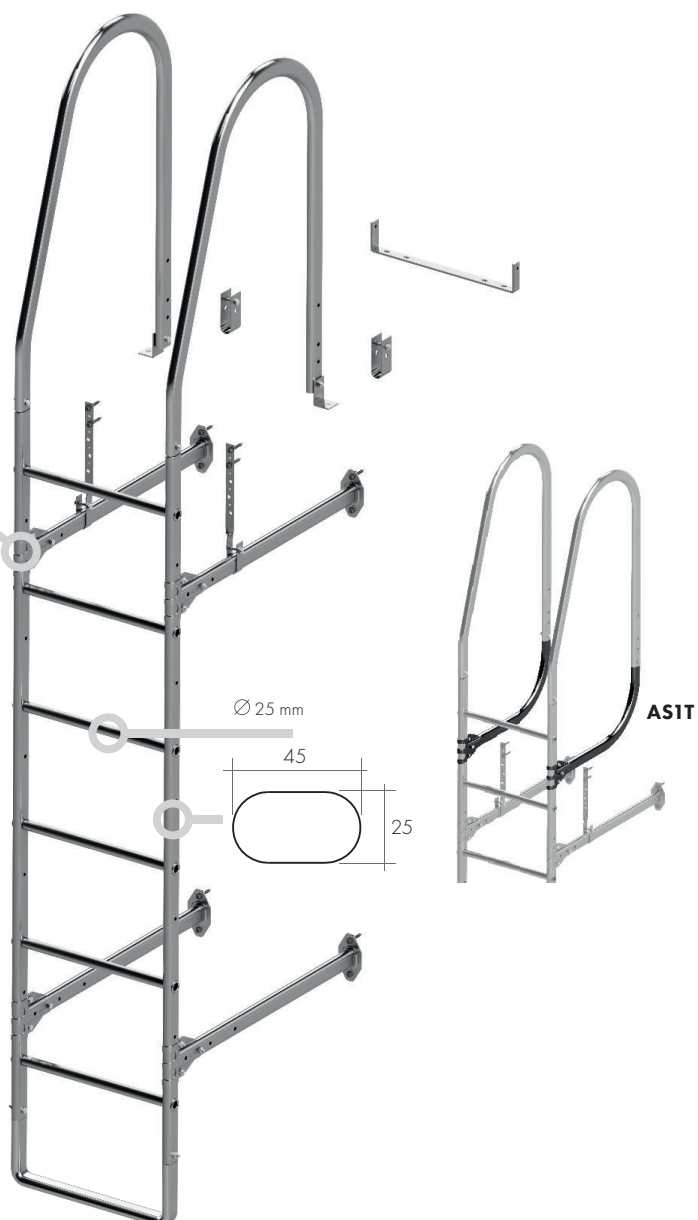
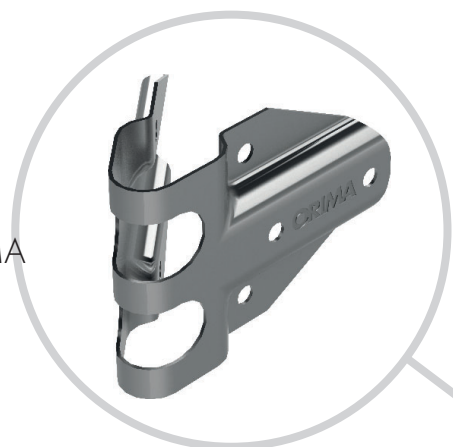
SIENAS KĀPNES

SAVIENOJUMA
PLĀKSNE
20290

































PRODUKTI	KODS	PIEGĀDES LAIKS	EUR*	EUR* BEZ PVN	KOPĒJAIS GARUMS					
					5,4 m	6 m	6,6 m	7,5 m	8,4 m	
KĀPŅU MODUĻI										
 1,2 m	21120	5		29,95						
 2,7 m	20040	5		64,68	2 gb.	1 gb.				
 3,3 m	21130	5		76,51		1 gb.	2 gb.	1 gb.		
 4,2 m	20070	5		95,77				1 gb.	2 gb.	
 PLASTMASAS AIZBĀZNIS	20150	5		0,95						

*Standarta krāsas:

RR20 Balta RR23 Tumši pelēka RR29 Sarkana RR32 Tumši brūna RR33 Melna RR750 Ķieģeļu sarkana

RR11 Tumši zaļa** RR21 Gaiši pelēka** **Pēc pieprasījuma

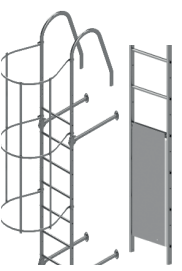
Īpašās krāsa +20 % (Pēc pieprasījuma), Krāsa ar metālisku spīdumu +30 % (Pēc pieprasījuma)

PRODUKTI		KODS	PIEGĀDES LAIKS	EUR*	EUR* BEZ PVN	APRAKSTS
SIENAS KĀPNES						
	1,2 m 					
	2,7 m 	+ SAS1				ATBALSTU SKAITS 4
	3,3 m 					
	4,2 m 					
	5,4 m  	2 x 2,7 m + SAS1 + SAS1L				ATBALSTU SKAITS 6
	6 m  	2,7 m + 3,3 m				
	6,6 m  	2 x 3,3 m				
	7,5 m  	3,3 m + 4,2 m + SAS1 + 2 x SAS1L				ATBALSTU SKAITS 8
8,4 m  	2 x 4,2 m					
	MONTĀŽAS KOMPLEKTS AS1	85–100 cm 	SAS1	5	119,62	1 gb./ 3,6 m sienas kāpnes
		20 cm 	SAS120	5	88,58	
		25–40 cm 	SAS140	5	93,87	
		55–70 cm 	SAS170	5	111,50	
		115–130 cm 	SAS1130	5	131,54	
	SAVIENOJUMA PLĀKSNE	20290	5	2,67		
	AUGŠĒJĀS KĀPŅU MARGAS	20080	5	17,35		
U-VEIDA STIPRINĀJUMS PIE JUMTA	20120	5	2,55			
L-VEIDA STIPRINĀJUMS PIE JUMTA	20130	5	2,25			
STIPRINĀJUMS PIE KARNĪZES	20140	5	3,74			
	PAPILDUS KOMPLEKTS AS1L	85–100 cm 	SAS1L	5	33,41	1 gb. / 3 m
		20 cm 	SAS1L20	5	23,01	
		25–40 cm 	SAS1L40	5	24,31	
		55–70 cm 	SAS1L70	5	28,72	
		115–130 cm 	SAS1L130	5	38,74	
	ATBALSTS MARGAI AS1T		SAS1T	5	30,21	
		AUGŠĒJĀIS TRUBAS ATBALSTS	20540	5	11,65	
		ATBALSTS	35620	5	19,77	
		STIPRINĀJUMS PIE JUMTA LAIPAS	20260	5	7,47	
	APAKŠĒJĀIS PAKĀPIENS	Augstums 165 mm	20250	5	11,23	
		STIPRINĀJUMS PAROC	20640	10	24,41	
	DROŠĪBAS NOŽOGOJUMS	0,9 m 	20400	10	51,67	
		2,1 m 	20440	10	72,24	
	DROŠĪBAS NOŽOGOJUMS SIENAS KĀPNĒM	24010	10	28,16		
	VERTIKĀLĀ PLĀKSNE 900 mm	24020	10	7,61		
	KOMPLEKTS AIZSARGREŽĢA MONTĀŽAI	35271	10	1,64		

AVĀRIJAS KĀPNES

PRODUKTI	APRAKSTS
<p>AVĀRIJAS KĀPNES</p> <p>1,2 m </p> <p>_____ + SAS8</p> <p>2,7 m </p> <p>_____</p> <p>3,3 m </p> <p>_____ + SAS8 + SAS8L</p> <p>4,2 m </p>	<p>ATBALSTU SKAITS 4</p> <p>ATBALSTU SKAITS 6</p>

PRODUKTI	KODS	PIEGĀDES LAIKS	EUR*	EUR* BEZ PVN	APRAKSTS
<p>AS8</p>	MONTĀŽAS KOMPLEKTS AS8	SAS8	5	37,03	1 gb. / 3,0 m avārijas kāpnes
	PAPILDUS KOMPLEKTS AS8L	SAS8L	5	8,17	1 gb. / 3,0 m
	AUGŠĒJAIS ATBALSTS	20160	5	9,63	
	AUGŠĒJĀ ATBALSTA STIPRINĀJUMS	20500	5	3,87	
	ATBALSTS	20380	5	3,62	
<p>AS5</p>	MONTĀŽAS KOMPLEKTS AS5U	1,5 m	SAS5U	5	35,96
	PĀREJAS CAURULES STIPRINĀJUMS		20970	5	7,10
	PĀREJAS CAURULE	1,5 m	20630	5	12,64

PRODUKTI	KODS	PIEGĀDES LAIKS	EUR*	EUR* BEZ PVN	KOPĒJAIS GARUMS				
					5,4 m	6 m	6,6 m	7,5 m	8,4 m
<p>KĀPŅU MODUĻI</p>	1,2 m	21120	5	29,95					
	2,7 m	20040	5	64,68	2 gb.	1 gb.			
	3,3 m	21130	5	76,51		1 gb.	2 gb.	1 gb.	
	4,2 m	20070	5	95,77				1 gb.	2 gb.
<p>PLASTMASAS AIZBĀZNIS</p>	20150	5	0,95						

*Standarta krāsas: RR20 Balta RR23 Tumši pelēka RR29 Sarkana RR32 Tumši brūna RR33 Melna RR750 Ķieģeļu sarkana

RR11 Tumši zaļa** RR21 Gaiši pelēka** **Pēc pieprasījuma

Īpašās krāsa +20 % (Pēc pieprasījuma), Krāsa ar metālisku spīdumu +30 % (Pēc pieprasījuma)

JUMTA KĀPNES, PAKĀPIENI

PRODUKTI	KODS	PIEGĀDES LAIKS	EUR*	EUR* BEZ PVN	APRAKSTS	
<p>JUMTA KĀPNES</p>	1,2 m	22010	5	77,86		
	2,4 m	22030	5	108,34		
	NOŽOGOJUMS PIE MODUĻVEIDA KĀPNĒM	2,4 m AUGSTUMS 0,6 m	SVR	10	60,09	
	NOŽOGOJUMA VIDĒJĀ DAĻĀ	2,5 m AUGSTUMS 0,6 m	SVRL	10	33,77	

PRODUKTI	KODS	PIEGĀDES LAIKS	EUR*	EUR* BEZ PVN	APRAKSTS
KR1 C2 <p>STIPRINĀJUMS PIE KORES</p>	20180	5	3,36	 CE C2	

KR6 C2 <p>SIJAS VEIDA KĀPNŪ STIPRINĀJUMS</p>	20520	5	13,71	 CE C2
<p>STIPRINĀJUMS TRAPECEVEIDA PROFILAM</p>	34280	10	16,10	 CE C2

KR2 C2 <p>STIPRINĀJUMA ELEMENTS UZ FALCES</p>	22156	5	7,86	 CE C2 405-540 mm Magnelis®
---	-------	---	------	---

<p>PAKĀPIENI UZ DABĪGĀ DAKSTIŅĀ</p>	23090	10	23,14	 UZMANĪBU! Šiem produktiem nav CE-marķējums 50 x 50 mm
-------------------------------------	-------	----	-------	---

* Standarta krāsas: **RR20 Balta** **RR23 Tumši pelēka** **RR29 Sarkana** **RR32 Tumši brūna** **RR33 Melna** **RR750 Ķieģeļu sarkana**

RR11 Tumši zaļa** **RR21 Gaiši pelēka**** **Pēc pieprasījuma

Īpašās krāsa +20 % (Pēc pieprasījuma), **Krāsa ar metālisku spīdumu +30 %** (Pēc pieprasījuma)

JUMTA KĀPNES

PRODUKTI	KODS	PIEGĀDES LAIKS	EUR*	EUR* BEZ PVN	KOPĒJAIS GARUMS				
					5,4 m	6 m	6,6 m	7,5 m	8,4 m
KĀPŅU MODUĻI									
1,2 m	21120	5		29,95					
2,7 m	20040	5		64,68	2 gb.	1 gb.			
3,3 m	21130	5		76,51		1 gb.	2 gb.	1 gb.	
4,2 m	20070	5		95,77				1 gb.	2 gb.
PLASTMASAS AIZBĀZNIS	20150	5		0,95					

PRODUKTI	KODS	PIEGĀDES LAIKS	EUR*	EUR* BEZ PVN	APRAKSTS
AS3 C2					
3,3 m					+ SAS3C2
4,2 m					+ SAS3C2
5,4 m					+ SAS3C2
6,0 m					+ SAS3C2 + SAS3L
6,6 m					+ SAS3C2 + SAS3L
7,5 m					+ SAS3C2 + SAS3L
MONTĀŽAS KOMPLEKTS AS3 C2	SAS3C2	5		40,97	2 x STIPRINĀJUMS PIE KORES + 10 x PLASTMASAS ATBALSTS 1 gb. SAS3C2 / 6 m
MONTĀŽAS KOMPLEKTS AS3L	SAS3L	5		8,98	2 x METĀLA ATBALSTS UZ JUMTA
PLASTMASAS ATBALSTS	20240	5		3,25	
STIPRINĀJUMS PIE KORES	20180	5		3,36	
METĀLA ATBALSTS UZ JUMTA	20320	5		3,62	

PRODUKTI	KODS	PIEGĀDES LAIKS	EUR*	EUR* BEZ PVN	APRAKSTS
AS3B					
3,3 m					+ SAS3B
4,2 m					+ SAS3B
5,4 m					+ SAS3B + SAS3BL
6,0 m					+ SAS3B + SAS3BL
6,6 m					+ SAS3B + 2 x SAS3BL
7,5 m					+ SAS3B + 3 x SAS3BL
MONTĀŽAS KOMPLEKTS AS3B	SAS3B	5		70,46	4 x SIJAS VEIDA KĀPŅU STIPRINĀJUMS + 2 STIPRINĀJUMS PIE KORES 1 gb. SAS3B / 4,2 m
MONTĀŽAS KOMPLEKTS AS3B PAPILD.	SAS3BL	5		15,68	1 x SIJAS VEIDA KĀPŅU STIPRINĀJUMS 1 gb. SAS3B / 3 m
SIJAS VEIDA KĀPŅU STIPRINĀJUMS	20520	5		13,71	
STIPRINĀJUMS PIE KORES	20180	5		3,36	

*Standarta krāsas:

RR20 Balta RR23 Tumši pelēka RR29 Sarkana RR32 Tumši brūna RR33 Melna RR750 Ķieģeļu sarkana

RR11 Tumši zaļa** RR21 Gaiši pelēka** **Pēc pieprasījuma

Īpašās krāsa +20 % (Pēc pieprasījuma), Krāsa ar metālisku spīdumu +30 % (Pēc pieprasījuma)

PRODUKTI	KODS	PIEGĀDES LAIKS	EUR*	EUR* BEZ PVN	APRAKSTS
AS2 C2 	3,3 m		+ SAS2C2		 CE C2
	4,2 m		+ SAS2C2		
	5,4 m 2,7 m + 2,7 m		+ SAS2C2		
	6,0 m 2,7 m + 3,3 m		+ SAS2C2 + SAS2LC2		
	6,6 m 3,3 m + 3,3 m		+ SAS2C2 + SAS2LC2		
	7,5 m 3,3 m + 4,2 m		+ SAS2C2 + SAS2LC2		
MONTĀŽAS KOMPLEKTS UZ FALCES AS2 C2	SAS2C2	5	73,22	2 x STIPRINĀJUMA ELEMENTS UZ FALCES + 4 x CILPAS STIPRINĀJUMS + 8 x PLASTMASAS ATBALSTS 1 gb.. SAS2C2 / 5,1 m	
MONTĀŽAS KOMPLEKTS UZ FALCES AS2LC2 PAPILD.	SAS2LC2	5	36,84	1 x STIPRINĀJUMA ELEMENTS UZ FALCES + 2 x CILPAS STIPRINĀJUMS + 4 x PLASTMASAS ATBALSTS 1 gb.. AS2LC2 / 5 m	
STIPRINĀJUMA ELEMENTS UZ FALCES	22440	5	15,27	C2	
CILPAS STIPRINĀJUMS	20420	5	2,99		
PLASTMASAS ATBALSTS	20240	5	3,25		

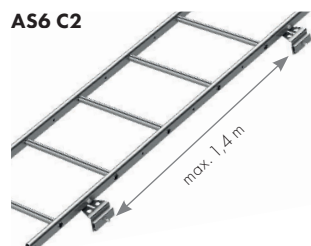
AS6 C2

 STIPRINĀJUMA ELEMENTS UZ FALCES **AS6 C2**

22060 5

7,40

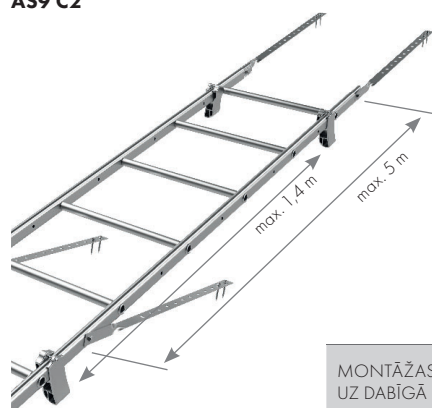
CEC2
540 mm

AS9 C2

3,3 m + SAS9C2

4,2 m + SAS9C2

 5,4 m
2,7 m + 2,7 m + 2 x SAS9C2

 6,0 m
2,7 m + 3,3 m + 2 x SAS9C2

 6,6 m
3,3 m + 3,3 m + 2 x SAS9C2

 7,5 m
3,3 m + 4,2 m + 2 x SAS9C2

CEC2

 MONTĀŽAS KOMPLEKTS UZ DABĪGĀ DAKSTIŅĀ **AS9**

SAS9C2 5

48,53

 4 x STIPRINĀJUMS PIE KĒRES + 10 x PLASTMASAS ATBALSTS
1 gb.. SAS9C2 / 5,1 m

PLASTMASAS ATBALSTS

20240 5

3,25







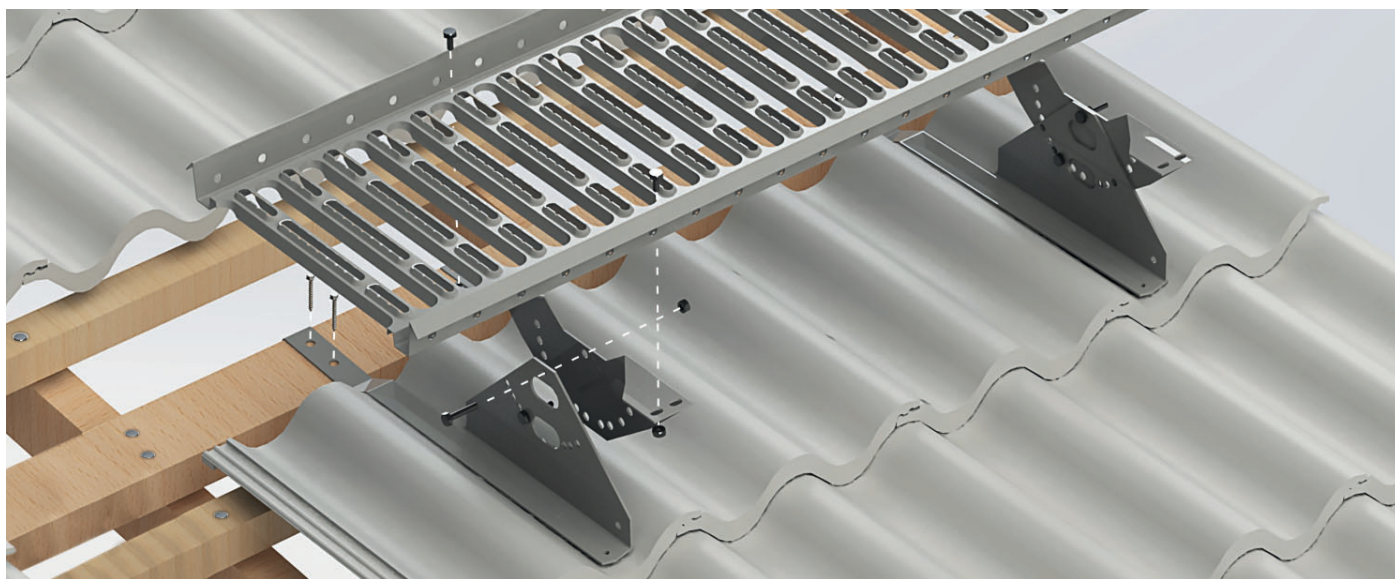

STIPRINĀJUMS PIE KĒRES

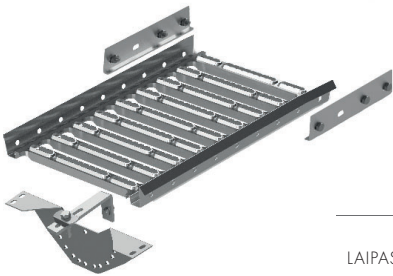
20180 5

3,36

JUMTA LAIPAS















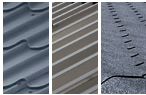





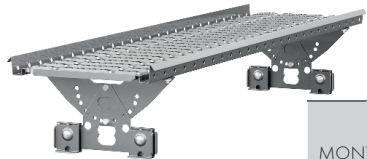







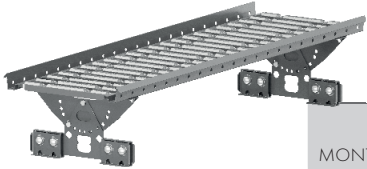







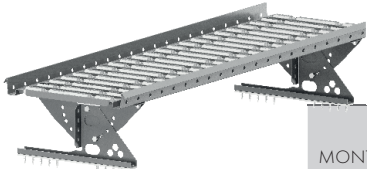







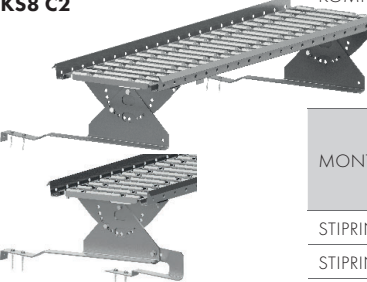







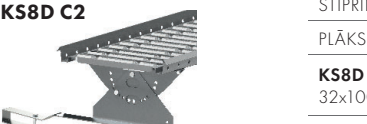







PRODUKTI		KODS	PIEGĀDES LAIKS	EUR*	EUR* BEZ PVN	APRAKSTS
JUMTA LAIPA 	0,60 m 	30640	10		20,36	
	1,21 m 	30010	5		37,04	Platums 350 mm
	2,25 m 	30200	5		53,47	
	2,97 m 	30030	5		71,25	
	LAIPAS FIKSATORS	30060	5		6,01	
SAVIENOJUMA PLĀKSNE	30040	5		2,06	1 gb.	
LAIPAS ATBALSTS	35110	5		4,73		
	JUMTA LAIPAS NOŽOGOJUMS	1,2 m 	35140	10	117,84	
	SVL 	JUMTA LAIPAS NOŽOGOJUMS	3,0 m 	SVL	10	125,56
BEIGU ATBALSTS		35130	10		42,35	

*Standarta krāsas:

RR20 Balta RR23 Tumši pelēka RR29 Sarkana RR32 Tumši brūna RR33 Melna RR750 Ķieģeļu sarkana

RR11 Tumši zaļa** RR21 Gaiši pelēka** **Pēc pieprasījuma

Īpašās krāsa +20 % (Pēc pieprasījuma), Krāsa ar metālisku spīdumu +30 % (Pēc pieprasījuma)

PRODUKTI		KODS	PIEGĀDES LAIKS	EUR*	EUR* BEZ PVN	APRAKSTS		
	KOMPLEKTI	0,6 m*		STJRC2	10	65,10		
		1,21 m		STOC2	5	100,57		
		2,25 m		STNC2	5	117,00		
		2,97 m		STFC2	5	146,32		
	MONTĀŽAS KOMPLEKTI	0,6 m*		STJRC2	5	63,53		CEc2
		1,21 m/2,25 m		STNC2	5	63,53		
		2,97 m		STFC2	5	75,07		
		STIPRINĀJUMS PIE JUMTA		30630	5	8,75		
	KOMPLEKTI	0,6 m		STJJO	10	68,19		
		1,21 m		STTL	5	84,87		
		2,25 m		STTG	5	120,37		
		2,97 m		STTA	5	152,50		
	MONTĀŽAS KOMPLEKTI	0,6 m/1,21 m		STTLZ	5	47,83		CEc1
		2,25 m		STTGZ	5	66,90		
		2,97 m		STTAZ	5	81,24		
		STIPRINĀJUMA KOMPLEKTS UZ FALCES		35640	5	12,50		
	KOMPLEKTI	0,6 m*		STJOC2	10	76,33		
		1,21 m		STLIC2	5	116,16		
		2,25 m		STGC2	5	132,58		
		2,97 m		STAC2	5	168,78		
	MONTĀŽAS KOMPLEKTI	0,6 m*		STJOC2	5	55,97		CEc2
		1,21 m/2,25 m		STGC2	5	79,12		
		2,97 m		STAC2	5	97,53		
		STIPRINĀJUMA KOMPLEKTS UZ FALCES C2		35820	5	16,57		
	KOMPLEKTI	0,6 m*		STJJS	10	69,45		
		1,21 m		STDBC2	5	105,93		
		2,25 m		STDA	5	122,36		
		2,97 m		STTD	5	155,05		
	MONTĀŽAS KOMPLEKTI	0,6 m*		STJJSZ	5	49,09		CEc2
		1,21 m/2,25 m		STDAZ	5	68,89		
		2,97 m		STTDZ	5	83,80		
		STIPRINĀJUMS UZ PROFILA		30530	5	10,46		
	KOMPLEKTI	0,6 m*		STTJ	10	70,34		
		1,21 m		STTIC2	5	107,17		
		2,25 m		STTH	5	123,60		
		2,97 m		STTC	5	156,80		
	MONTĀŽAS KOMPLEKTI	0,6 m*		STTJZ	5	49,98		CEc2
		1,21 m/2,25 m		STTHZ	5	70,13		
		2,97 m		STTCZ	5	85,55		
		STIPRINĀJUMS DABĪGAM DAKSTIŅAM		31050	5	13,15		
STIPRINĀJUMS BIBER		31590	10	13,08	1,2 m, 50 x 100			
	STIPRINĀJUMA BALSTS DABĪGAM DAKSTIŅAM		31680	10	6,60	1,2 m, 50 x 100		
	PLĀKSNE ZEM ATBALSTA		31690	10	2,36	1,2 m, 32 x 100		
	KS8D C2 STIPRINĀJUMS DABĪGAM DAKSTIŅAM 32x100 mm		30820	10	16,38	32 x 100 mm		
	32x100 mm		30830	10	4,05			
	KOMPLEKTI	0,6 m		STTETA	10	72,03		
		1,21 m		STTETB	10	88,71		
		2,25 m		STTETC	10	128,19		
		2,97 m		STTET	10	160,17		
	MONTĀŽAS KOMPLEKTI	0,6 m/1,21 m		STTETBZ	10	51,67		ETERNIT 920 x 585 mm Vai latus izmērs min. 50 x 50 mm
		2,25 m		STTETCZ	10	74,72		
		2,97 m		STTETZ	10	88,92		
		STIPRINĀJUMS PIE ETERNIT		31870	10	13,15		
	KOMPLEKTI	0,6 m		STTCEMA	10	72,03		
		1,21 m		STTCEMB	10	88,71		
		2,25 m		STTCEMC	10	128,19		
		2,97 m		STTCEM	10	160,17		
	MONTĀŽAS KOMPLEKTI	0,6 m/1,21 m		STTCEMBZ	10	51,67		CEMBRIT 625 mm
		2,25 m		STTCEMCZ	10	74,72		
		2,97 m		STTCEMZ	10	88,92		
		STIPRINĀJUMS PIE CEMBRIT		31850	10	13,15		

*CE apstiprinātām 2. klases rēķinām (ko izmanto kā piespīrināšanās vietu, lai persona izsargātos no kritieniem) vienmēr izmantojiet vismaz trīs stiprinājumus!

SNIEGA BARJERAS



SNIEGA BARJERU APRĒĶINA TABULA

Piemērs: Jumta slīpums 1:3 = 18°, sniega slodze 2 kN/m², maksimālais jumta laidums vienai sniega barjeras rindai 6,8 m

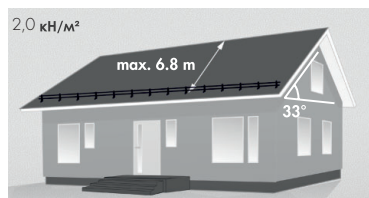

Jumta slīpums			SNIEGA SLODZE kN/m ² (~ 100 kg/m ²)					
			1	1,5	2	2,5	3	3,5
6°	~1:10	▲	60 m	40 m	30 m	24 m	20 m	17 m
10°	~1:5	▲	37 m	24 m	18 m	15 m	12 m	10 m
14°	1:4	▲	27 m	18 m	13 m	11 m	8,9 m	7,6 m
18°	1:3	▲	21 m	14 m	11 m	8,5 m	7,1 m	6,1 m
23°	~1:2,5	▲	17 m	12 m	8,7 m	7,0 m	5,8 m	5,0 m
27°	1:2	▲	15 m	10 m	7,7 m	6,2 m	5,2 m	4,4 m
33°	1:1,5	▲	14 m	9,1 m	6,8 m	5,5 m	4,6 m	3,9 m
38°		▲	13 m	8,6 m	6,4 m	5,2 m	4,3 m	3,7 m
42°		▲	13 m	8,4 m	6,3 m	5,0 m	4,2 m	3,6 m
45°	1:1	▲	13 m	8,3 m	6,3 m	5,0 m	4,2 m	3,6 m
50°		▲	13 m	8,5 m	6,3 m	5,1 m	4,2 m	3,6 m
55°		▲	13 m	8,9 m	6,7 m	5,3 m	4,4 m	3,8 m
60°		▲	14 m	9,6 m	7,2 m	5,8 m	4,8 m	4,1 m













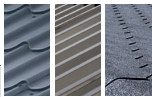

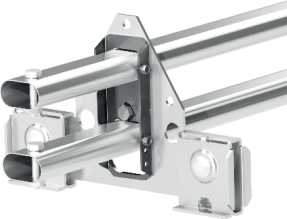
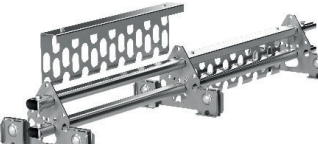















PRODUKTI	KODS	PIEĢĀDES LAIKS	EUR*	EUR* BEZ PVN	APRAKSTS
 OVĀLA CAURULE	3 m	31010	5	14,51	

*Standarta krāsas:

RR20 Balta RR23 Tumši pelēka RR29 Sarkana RR32 Tumši brūna RR33 Melna RR750 Ķieģeļu sarkana

RR11 Tumši zaļa** RR21 Gaiši pelēka** **Pēc pieprasījuma

Īpašās krāsa +20 % (Pēc pieprasījuma), Krāsa ar metālisku spīdumu +30 % (Pēc pieprasījuma)

	PRODUKTI	KODS	PIEGĀDES LAIKS	EUR*	EUR* BEZ PVN	APRAKSTS	
LE3 	KOMPLEKTI 3 m 	SLEK	5		72,54		
	MONTĀŽAS KOMPLEKTI 3 m 	SLEKZ	5		43,52		
	STIPRINĀJUMS PIE JUMTA	30630	5		8,75		1,2 m
LE2   	KOMPLEKTI 3 m 	SLEA	5		79,93		
	MONTĀŽAS KOMPLEKTI 3 m 	SLEAZ	5		50,92		
	STIPRINĀJUMA KOMPLEKTS UZ FALCES	35640	5		12,50	1,2 m	
	CAURULES MALU ATBALSTS	31800	10		5,15	Stiprināšanai 35640	
	UZLIKTNIS SNIEGA BARJERAS CAURULEI 500 mm 	31560	10		17,88	Uz falces	
	UZLIKTNIS SNIEGA BARJERAS CAURULEI 964 mm 	31580	10		30,61		
	UZLIKTNIS SNIEGA BARJERAS CAURULEI 441 mm 	31810	10		17,06		
UZLIKTNIS SNIEGA BARJERAS CAURULEI 920 mm 	31820	10		29,13	Classic tipa un valcprofila jumtiem		
LE6 	KOMPLEKTI 3 m 	SLEE	5		82,49		
	MONTĀŽAS KOMPLEKTI 3 m 	SLEEZ	5		53,47		
	STIPRINĀJUMS UZ PROFILA	30530	5		10,46		1,2 m
LE8  	KOMPLEKTI 3 m 	SLED	5		84,24		
	MONTĀŽAS KOMPLEKTI 3 m 	SLEDZ	5		55,22		
	STIPRINĀJUMS DABĪGAM DAKSTIŅAM	31050	5		13,15		1,2 m
	STIPRINĀJUMS BIBER	31590	10		13,08		1,2 m
	UZLIKTNIS SNIEGA BARJERAS CAURULEI 928 mm 	31830	10		29,13	Dabīgais dakstiņš Ormax	
LE8D 	LE8D STIPRINĀJUMS DABĪGAM DAKSTIŅAM	30820	10		16,38	1,2 m	
	32x100 mm	30830	10		4,05	32 x 100	
LE ET 	KOMPLEKTI 3 m 	SLET	10		87,61		
	MONTĀŽAS KOMPLEKTI 3 m 	SLETZ	10		58,59		
	STIPRINĀJUMS PIE ETERNIT	31870	10		13,15		1,2 m
LE CEM 	KOMPLEKTI 3 m 	SLEN	10		87,61		
	MONTĀŽAS KOMPLEKTI 3 m 	SLENZ	10		58,59		
	STIPRINĀJUMS PIE CEMBRIT	31850	10		13,15		1,2 m

PERFORĒTĀS SNIEGA BARJERAS

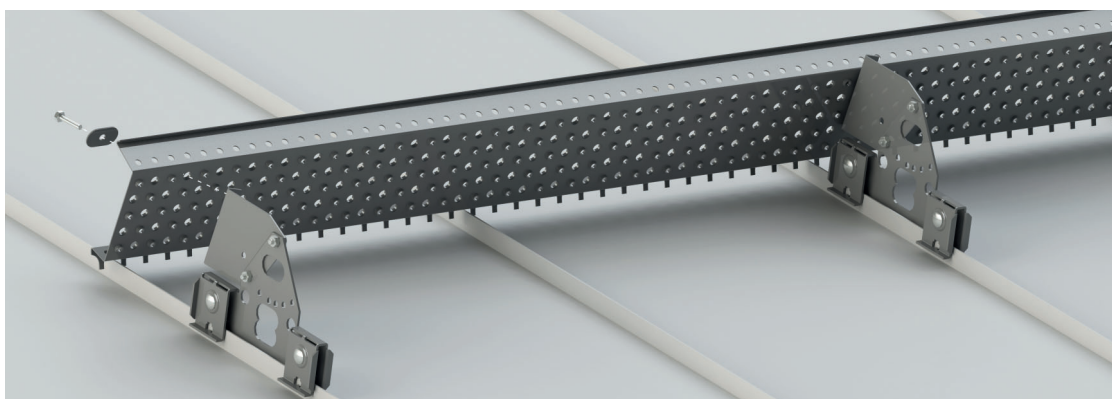

Sniega barjeru aprēķinu tabula
lpp. 18.

PRODUKTI	KODS	PIEGĀDES LAIKS	EUR*	EUR* BEZ PVN	APRAKSTS
SNIEGA BARJERAS REŽĢIS					
	SNIEGA BARJERAS REŽĢIS	1,23 m	32010	10	32,03
		2,46 m	32020	5	46,19
	SAVIENOJUMA PLĀKSNE		32030	5	2,83
	PADZIĻINĀTAIS REŽĢIS	2,46 m	32190	5	53,94
	REŽĢA STIPRINĀJUMA ELEMENTS		32140	5	4,54
	REŽĢA STIPRINĀJUMA KOMPLEKTS		35330	5	2,27

PRODUKTI	KODS	PIEGĀDES LAIKS	EUR*	EUR* BEZ PVN	APRAKSTS	
VLE3						
	MONTĀŽAS KOMPLEKTI VLE3	2,46 m	SLVKZ	5	54,31	
	STIPRINĀJUMS PIE JUMTA		30630	5	8,75	1,2 m
VLE2						
	MONTĀŽAS KOMPLEKTI VLE2	2,46 m	SILVAZ	5	65,26	
VLE2H						
	MONTĀŽAS KOMPLEKTI VLE2H	2,46 m	SILVCZ	5	68,77	
	STIPRINĀJUMA KOMPLEKTS UZ FALCES		35640	5	12,50	1,2 m
VLE5						
	MONTĀŽAS KOMPLEKTI VLE5	2,46 m	SILVEZ	5	47,39	
	STIPRINĀJUMS UZ PROFILA		30530	5	10,46	1,2 m
VLE8						
	MONTĀŽAS KOMPLEKTI VLE8	2,46 m	SILVPZ	5	63,09	
	STIPRINĀJUMS DABĪGAM DAKŠTĪŅAM		31050	5	13,15	1,2 m
	STIPRINĀJUMS BIBER		31590	10	13,08	

*Standarta krāsas:

RR20 Balta RR23 Tumši pelēka RR29 Sarkana RR32 Tumši brūna RR33 Melna RR750 Ķieģeļu sarkana

RR11 Tumši zaļa** RR21 Gaiši pelēka** **Pēc pieprasījuma

Īpašās krāsa +20 % (Pēc pieprasījuma), Krāsa ar metālisku spīdumu +30 % (Pēc pieprasījuma)

JUMTA NOŽOGOJUMI

PRODUKTI		KODS	PIEGĀDES LAIKS	EUR*	EUR* BEZ PVN	APRAKSTS	
SYP		KOMPLEKTI	GARUMS 3 m AUGSTUMS 0,6 m		SYP 10	123,39	
SYV		KOMPLEKTI	GARUMS 3 m AUGSTUMS 0,6 m		SYV 10	147,23	
					SYVL 10	177,18	
SYO		KOMPLEKTI AR SNIEGA BARJERU	GARUMS 3 m AUGSTUMS 1,1 m		SYO 10	189,26	
					SYOL 10	221,79	
SYT		KOMPLEKTI	GARUMS 3 m AUGSTUMS 0,6 m		SYT 10	159,92	
					SYTL 10	189,87	
SYS		KOMPLEKTI AR SNIEGA BARJERU	GARUMS 3 m AUGSTUMS 1,1 m		SYS 10	259,41	
					SYSL 10	289,36	
SYR		KOMPLEKTI	GARUMS 3 m AUGSTUMS 0,6 m		SYR 10	154,30	
					SYRL 10	184,25	
SYN		KOMPLEKTI AR SNIEGA BARJERU	GARUMS 3 m AUGSTUMS 1,1 m		SYN 10	198,43	
					SYNL 10	228,62	

*Standarta krāsas: **RR20 Balta** **RR23 Tumši pelēka** **RR29 Sarkana** **RR32 Tumši brūna** **RR33 Melna** **RR750 Ķieģeļu sarkana**

RR11 Tumši zaļa** **RR21 Gaiši pelēka**** **Pēc pieprasījuma

Īpašās krāsa +20 % (Pēc pieprasījuma), **Krāsa ar metālisku spīdumu +30 %** (Pēc pieprasījuma)

DROŠĪBAS SLIEDE

PRODUKTI	KODS	PIEGĀDES LAIKS	EUR*	EUR* BEZ PVN	APRAKSTS
SLIEDE					
 SLIEDE 3,0 m	33800	5		70,11	Sliede montējama gan horizontāli, gan vertikāli.
SLIEDES SAVIENOJOŠAIS ELEMENTS	33840	5		9,50	Viegla un izturīga.

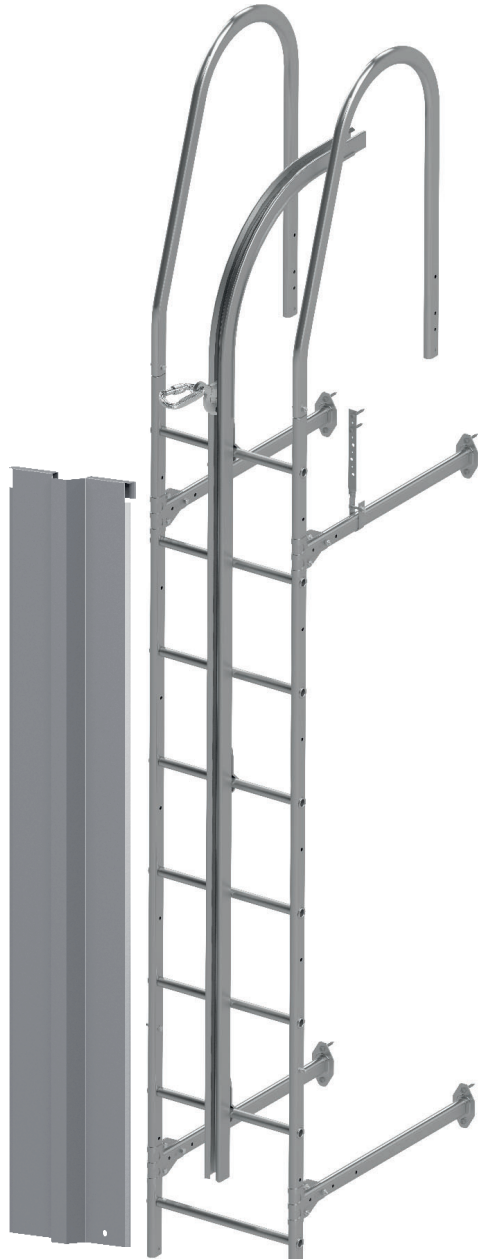



PRODUKTI	KODS	PIEGĀDES LAIKS	EUR*	EUR* BEZ PVN	APRAKSTS
VERTIKĀLĀS SLIEDES SISTĒMA					
 SLĪDOŠAIS STIPRINĀJUMS AR BLOĶĒTĀJU nerūsējošais tērauds	33880	5		251,76	Darba slodze (lietotāja svars, iesk. aprīkojumu): 40–160 kg Minimālā distance starp lietotājiem: 6 metri CE
VERTIKĀLĀ SLIEDE AR IELOCĪJUMU 2,6 m	33870	5		139,53	
SLIEDES KOMPLEKTS SĀNA IZEJAI	33780	10		283,05	
VERTIKĀLĀS SLIEDES STIPRINĀJUMS nerūsējošais tērauds	33860	5		12,50	Attālums starp stiprinājumiem 1,5 m
DROŠĪBAS NOŽOĢOJUMS	20340	10		196,16	Uz vertikālās sliedes
NOSAUKUMS PLATE, VERTIKĀLĀS SLIEDES SISTĒMA	33900	5		15,28	

*Standarta krāsas:

RR20 Balta RR23 Tumši pelēka RR29 Sarkana RR32 Tumši brūna RR33 Melna RR750 Ķieģeļu sarkana

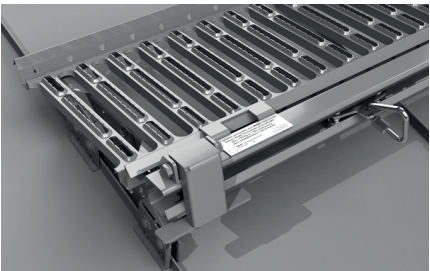
RR11 Tumši zaļa** RR21 Gaiši pelēka** **Pēc pieprasījuma

Īpašās krāsa +20 % (Pēc pieprasījuma), Krāsa ar metālisku spīdumu +30 % (Pēc pieprasījuma)

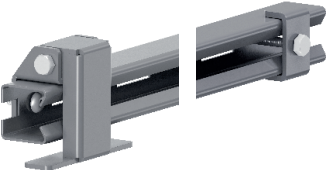
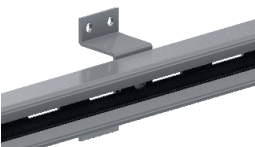
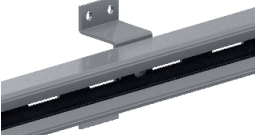
PRODUKTI	KODS	PIEGĀDES LAIKS	EUR*	EUR* BEZ PVN	APRAKSTS
HORIZONTĀLĀS SLIEDES SISTĒMA					
	<p>SLĪDOŠAIS STIPRINĀJUMS HORIZONTĀLĀI SLIEDEI nerūsējošais tērauds</p>  	33850	5	202,01	<p>Darba slodze (lietotāja svars, iesk. aprīkojumu): max 120 kg</p> <p>Minimālā distance starp lietotājiem: 3 metri</p>
	<p>MONTĀŽAS KOMPLEKTS HORIZONTĀLĀS SLIEDES STIPRINĀŠANAI PIE LAIPAS</p>	33890	5	6,62	
	<p>ĀTRAIS GALS HORIZONTĀLĀI SLIEDEI</p>	33810	5	28,69	
	<p>SLĒGTAIS GALS HORIZONTĀLĀI SLIEDEI</p>	33820	5	7,89	
	<p>MONTĀŽAS KOMPLEKTS HORIZONTĀLĀS SLIEDES STIPRINĀŠANAI PIE SIENAS</p>	33830	5	7,18	Attālums starp stiprinājumiem 2,0 m
	<p>NOSAUKUMS PLATE, HORIZONTĀLĀS SLIEDES SISTĒMA</p>	33910	5	15,28	

PRODUKTI	KODS	PIEGĀDES LAIKS	EUR*	EUR* BEZ PVN	APRAKSTS
	<p>KOMPLEKTI 3 m </p>	PHK3016	10	151,46	<p>1 x SLIEDE 3 m + 4 x STIPRINĀJUMS</p> 
	<p>KOMPLEKTI 1 STIPRINĀJUMS 1 gb. </p>	PHKL16	10	20,33	1,2 m
	<p>KOMPLEKTI 3 m </p>	PHK3013	10	136,75	<p>1 x SLIEDE 3 m + 4 x STIPRINĀJUMS</p> 
	<p>KOMPLEKTI 1 STIPRINĀJUMS 1 gb. </p>	PHKL13	10	16,66	1,2 m
	<p>KOMPLEKTI 3 m </p>	PHK3014	10	140,96	<p>1 x SLIEDE 3 m + 4 x STIPRINĀJUMS</p> 
	<p>KOMPLEKTI 1 STIPRINĀJUMS 1 gb. </p>	PHKL14	10	17,71	1,2 m
	<p>KOMPLEKTI 3 m </p>	PHK3012	10	162,58	<p>1 x SLIEDE 3 m + 4 x STIPRINĀJUMS</p> 
	<p>KOMPLEKTI 1 STIPRINĀJUMS 1 gb. </p>	PHKL12	10	23,12	1,2 m
	<p>KOMPLEKTI 3 m </p>	PHK3015	10	151,63	<p>1 x SLIEDE 3 m + 4 x STIPRINĀJUMS</p> 
	<p>KOMPLEKTI 1 STIPRINĀJUMS 1 gb. </p>	PHKL15	10	20,38	1,2 m

SNIEGA BARJERAS



LE3

METĀLA DAKSTIŅŠ UN MĪKSTIE SEGUMI



LE2

VALCPROFILS



LE6

DAŽĀDA TIPĀ JUMTA SEGUMI



LE8

DABĪGAIS DAKSTIŅŠ

PERFORĒTĀS SNIEGA BARJERAS

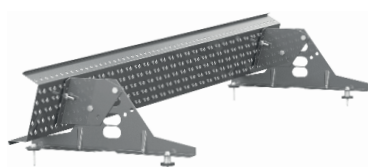

VLE3

METĀLA DAKSTIŅŠ UN MĪKSTIE SEGUMI



VLE2H

VALCPROFILS



VLE5

DAŽĀDA TIPĀ JUMTA SEGUMI



VLE8

DABĪGAIS DAKSTIŅŠ

JUMTA LAIPAS



KS4C2

METĀLA DAKSTIŅŠ UN MĪKSTIE SEGUMI



KS3C2

VALCPROFILS

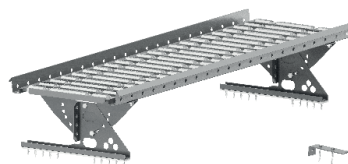

KS7C2

DAŽĀDA TIPĀ JUMTA SEGUMI



KS8C2

DABĪGAIS DAKSTIŅŠ

JUMTA NOŽOGOJUMI



SYOL

METĀLA DAKSTIŅŠ UN MĪKSTIE SEGUMI



SYN

VALCPROFILS



SYT

DAŽĀDA TIPĀ JUMTA SEGUMI



SYRL

VALCPROFILS